

COMPOSITE FACE FASTENED SYSTEM (DRY JOINT)

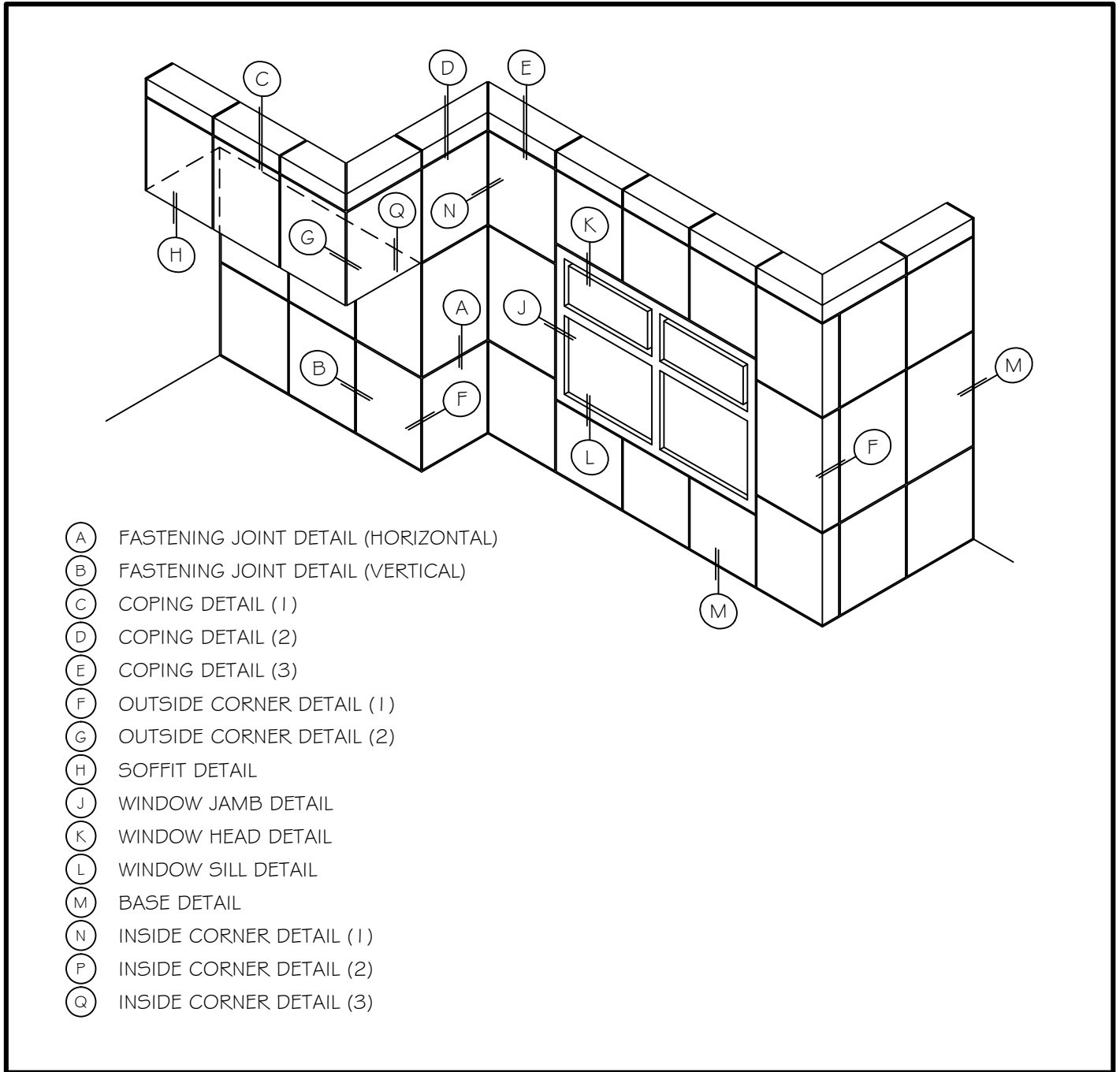

FASTENING JOINT DETAIL (HORIZONTAL)

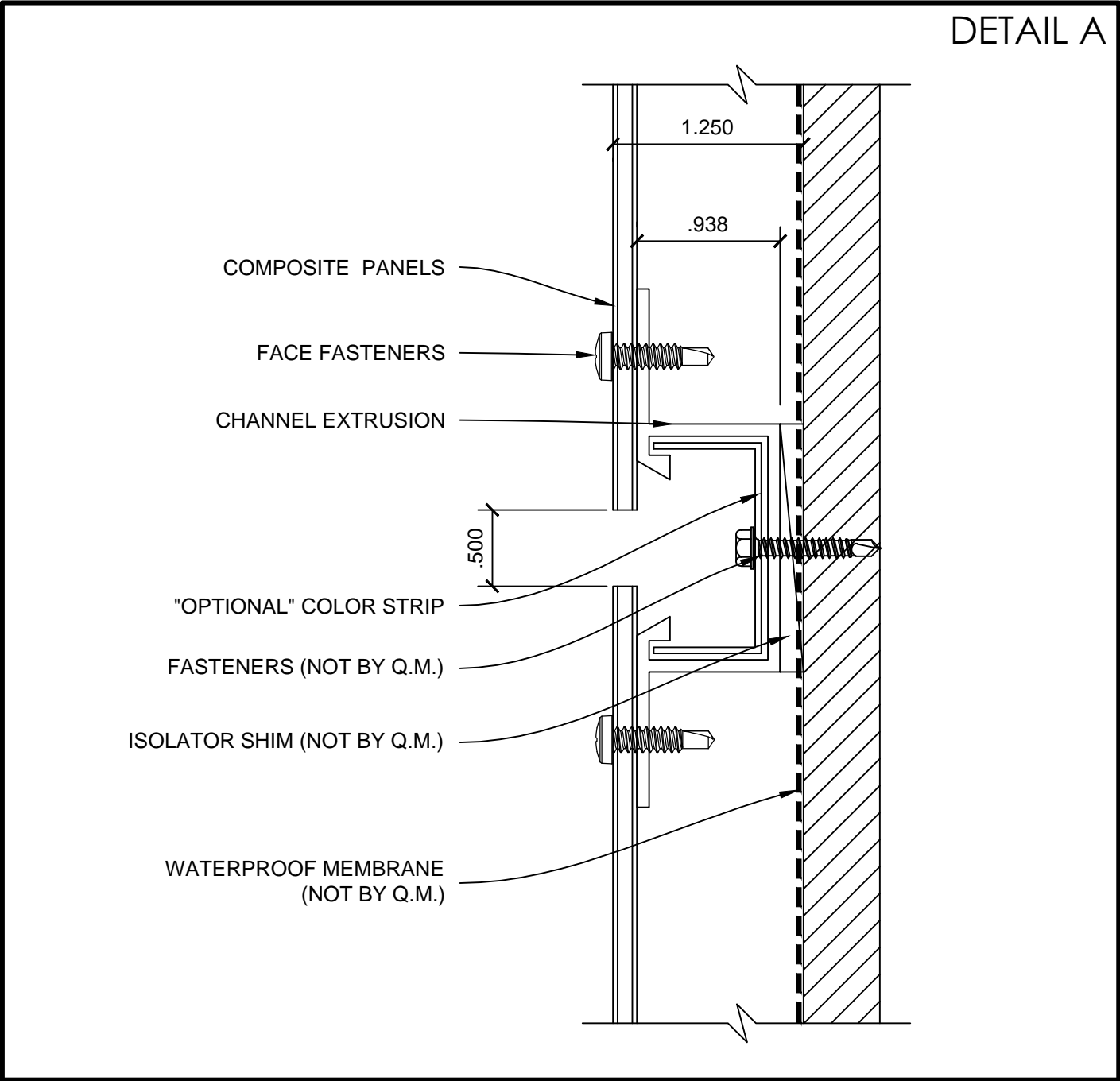

FASTENING JOIINT DETAIL (VERTICAL)

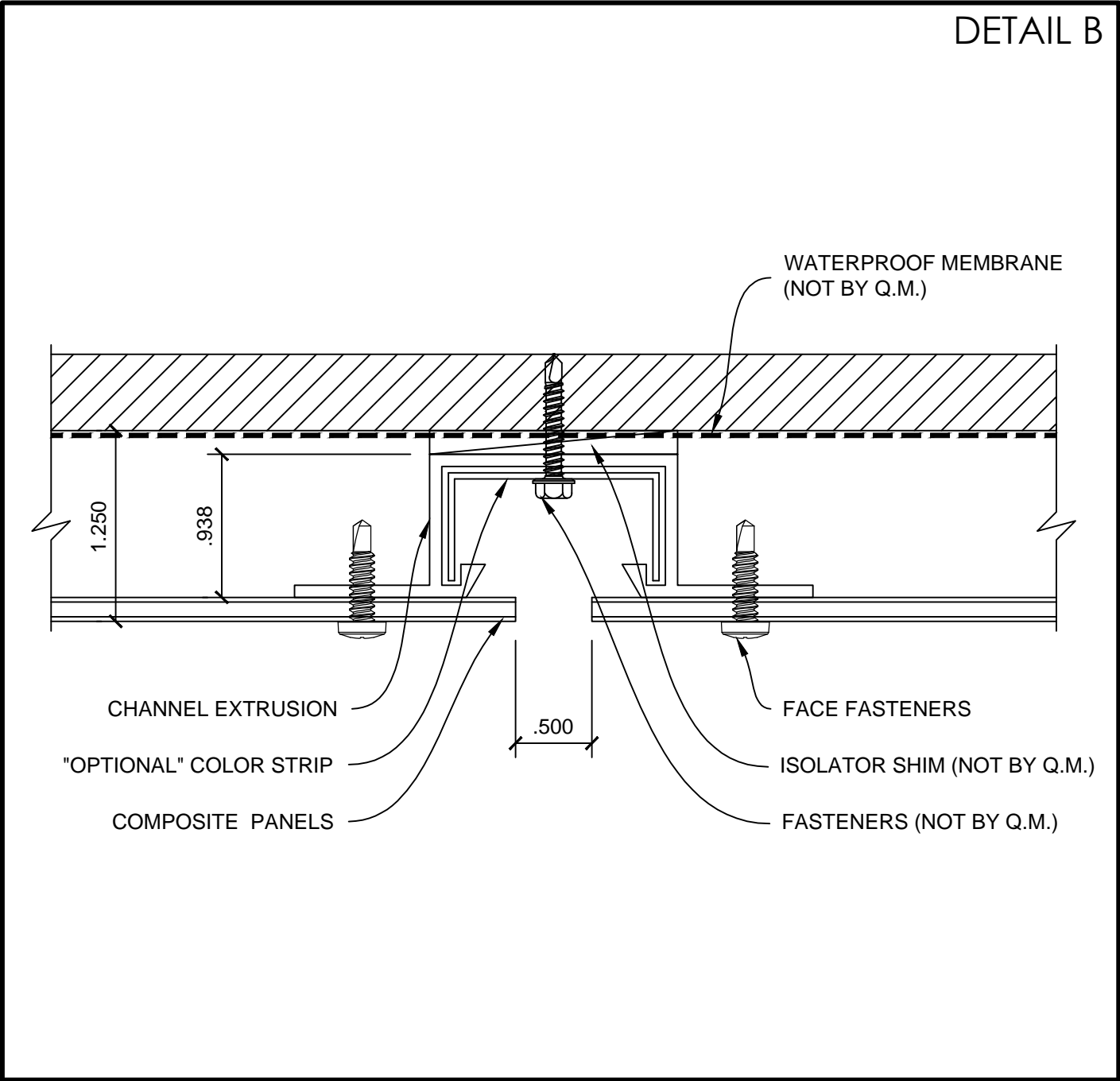

COPING DETAIL (1)

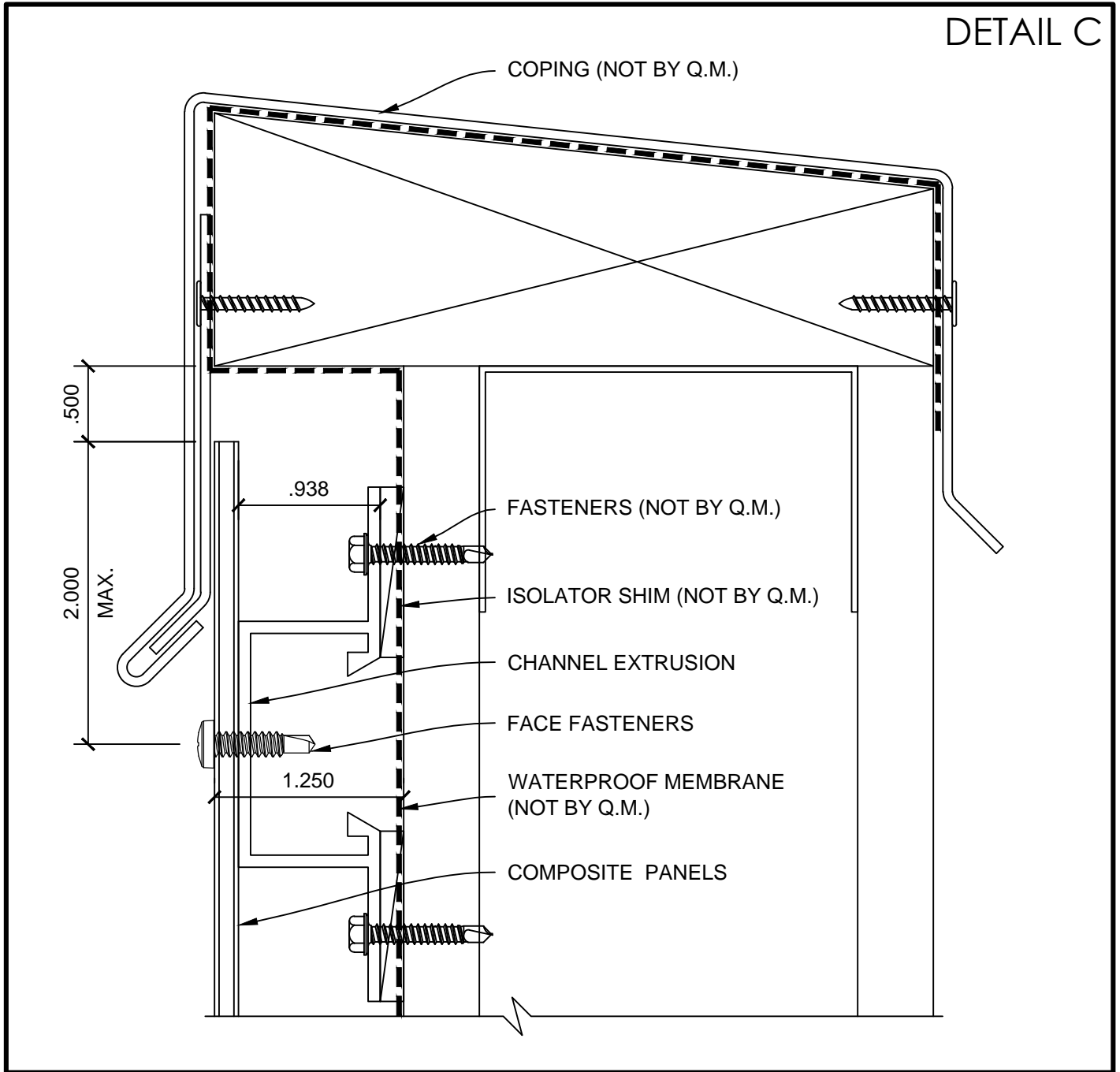

COPING DETAIL (2)

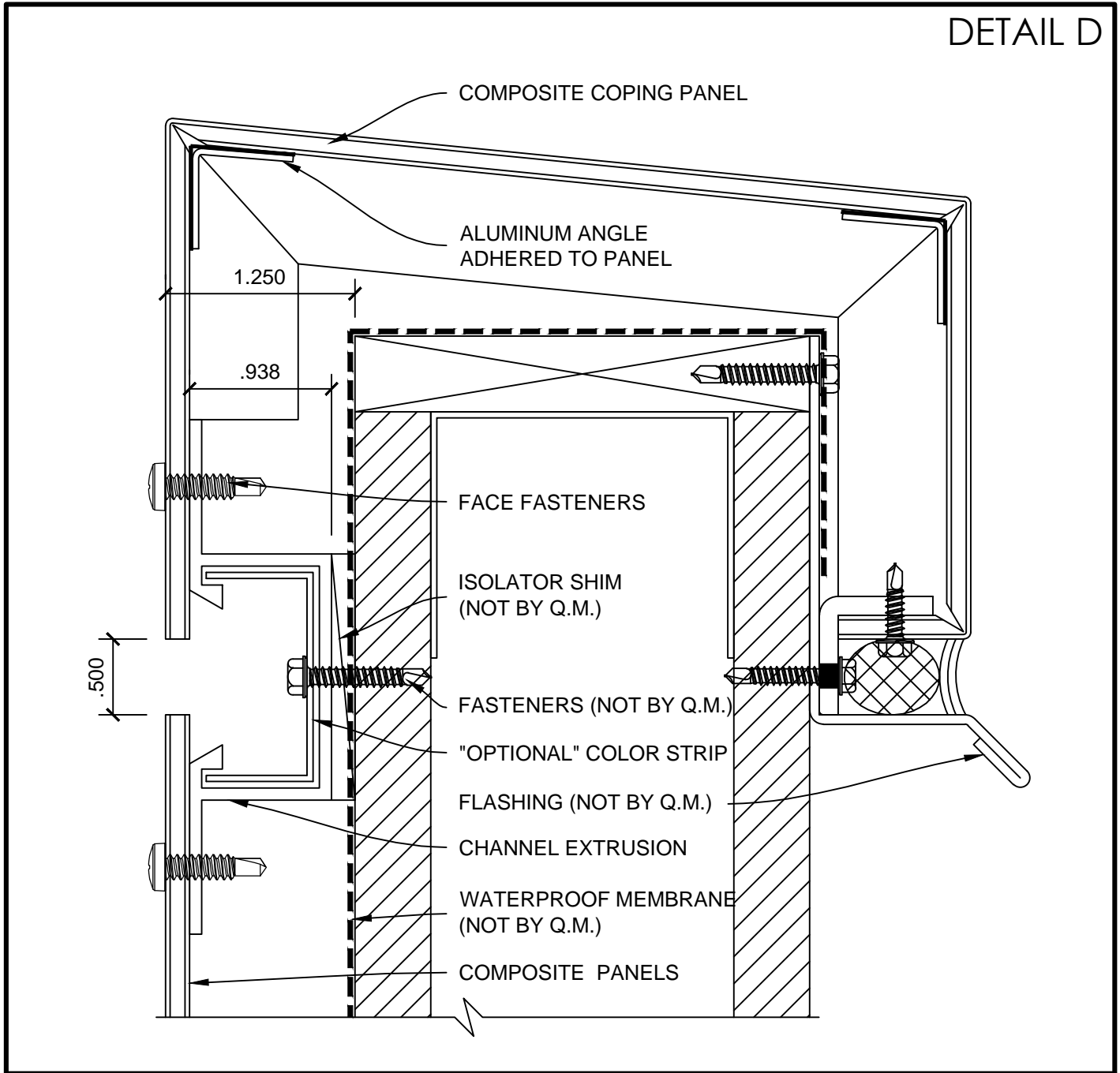

COPING DETAIL (3)

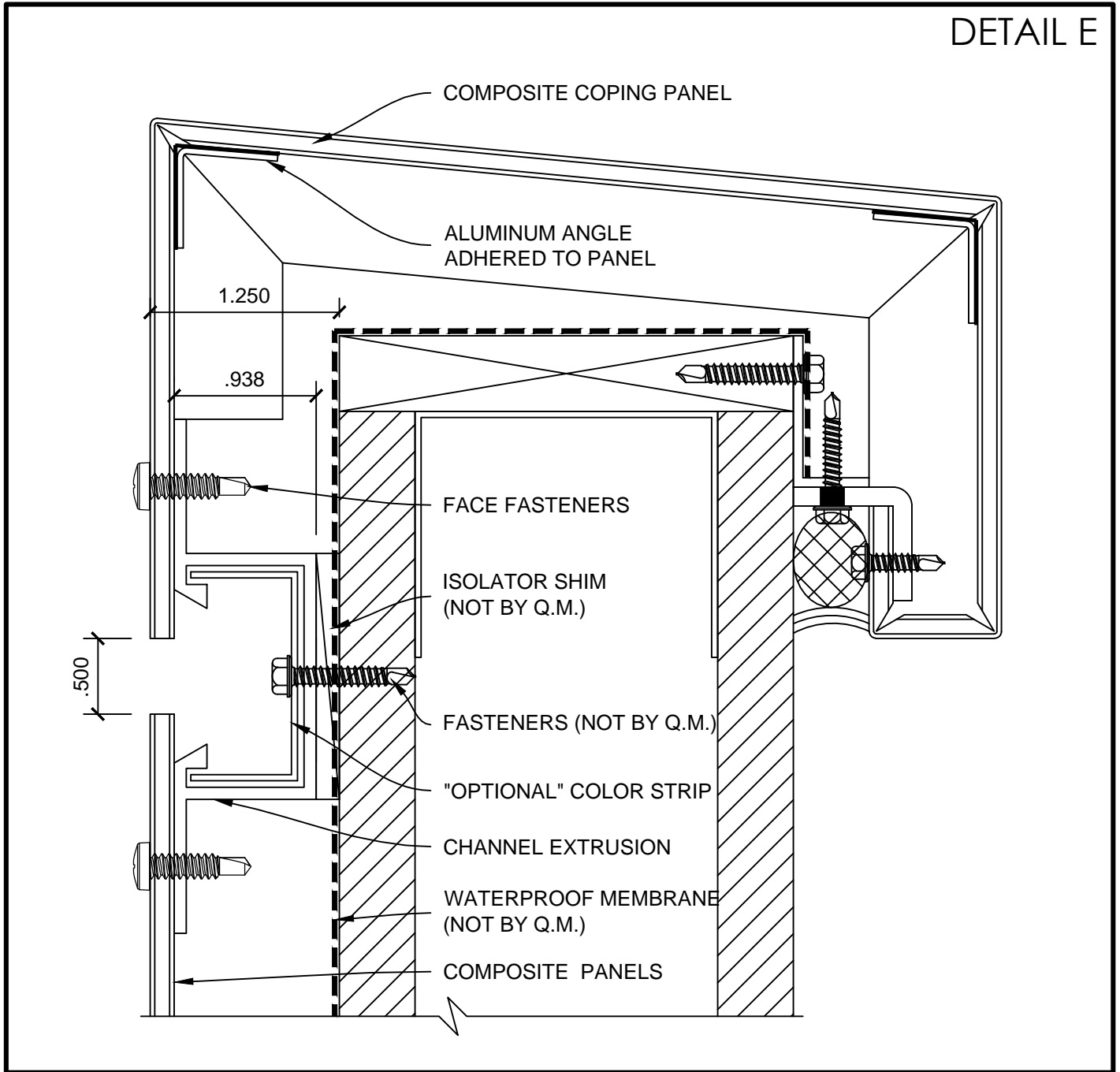

OUTSIDE CORNER DETAIL (1)

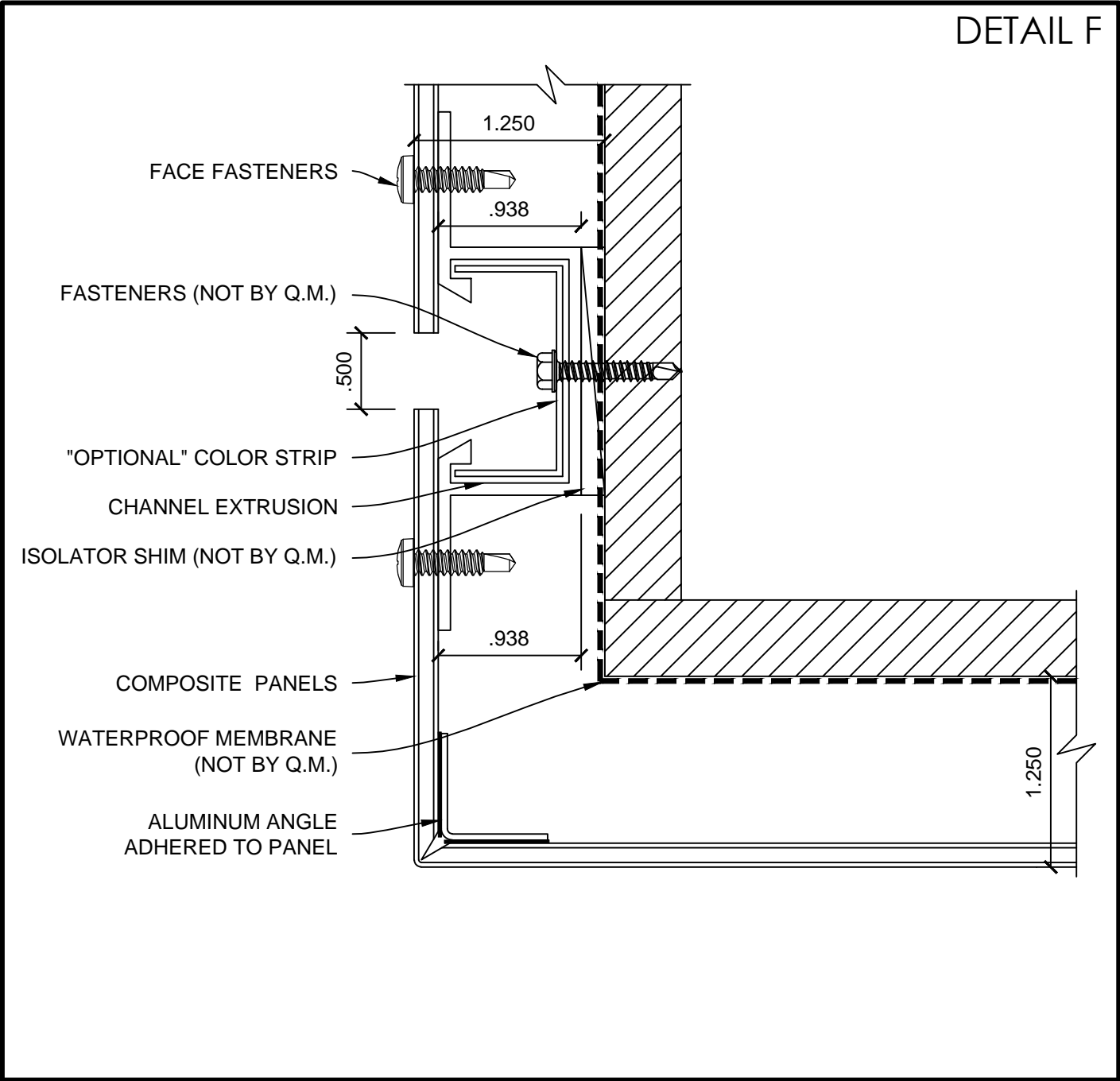

OUTSIDE CORNER DETAIL (2)

DETAIL G

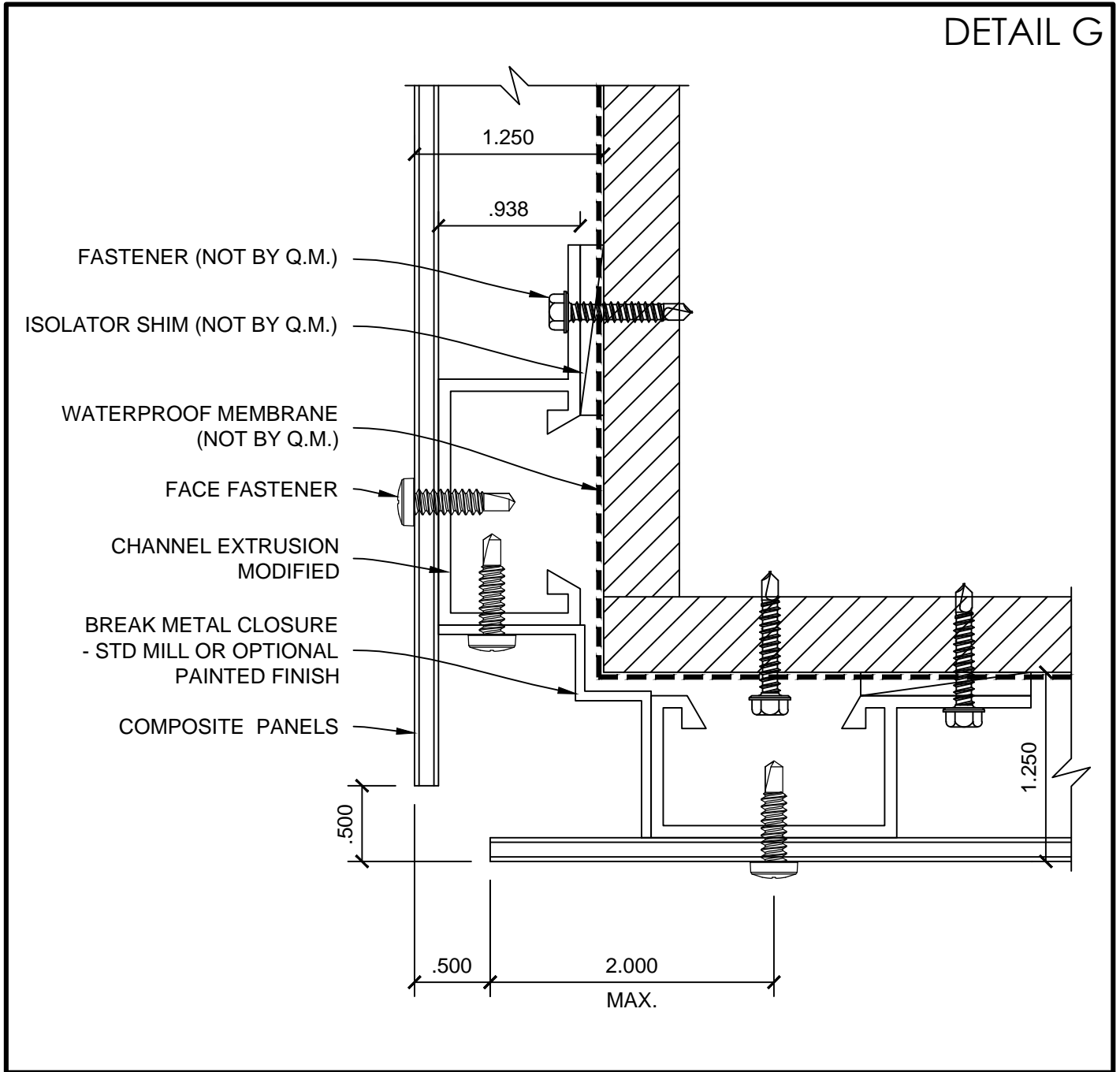



SOFFIT DETAIL

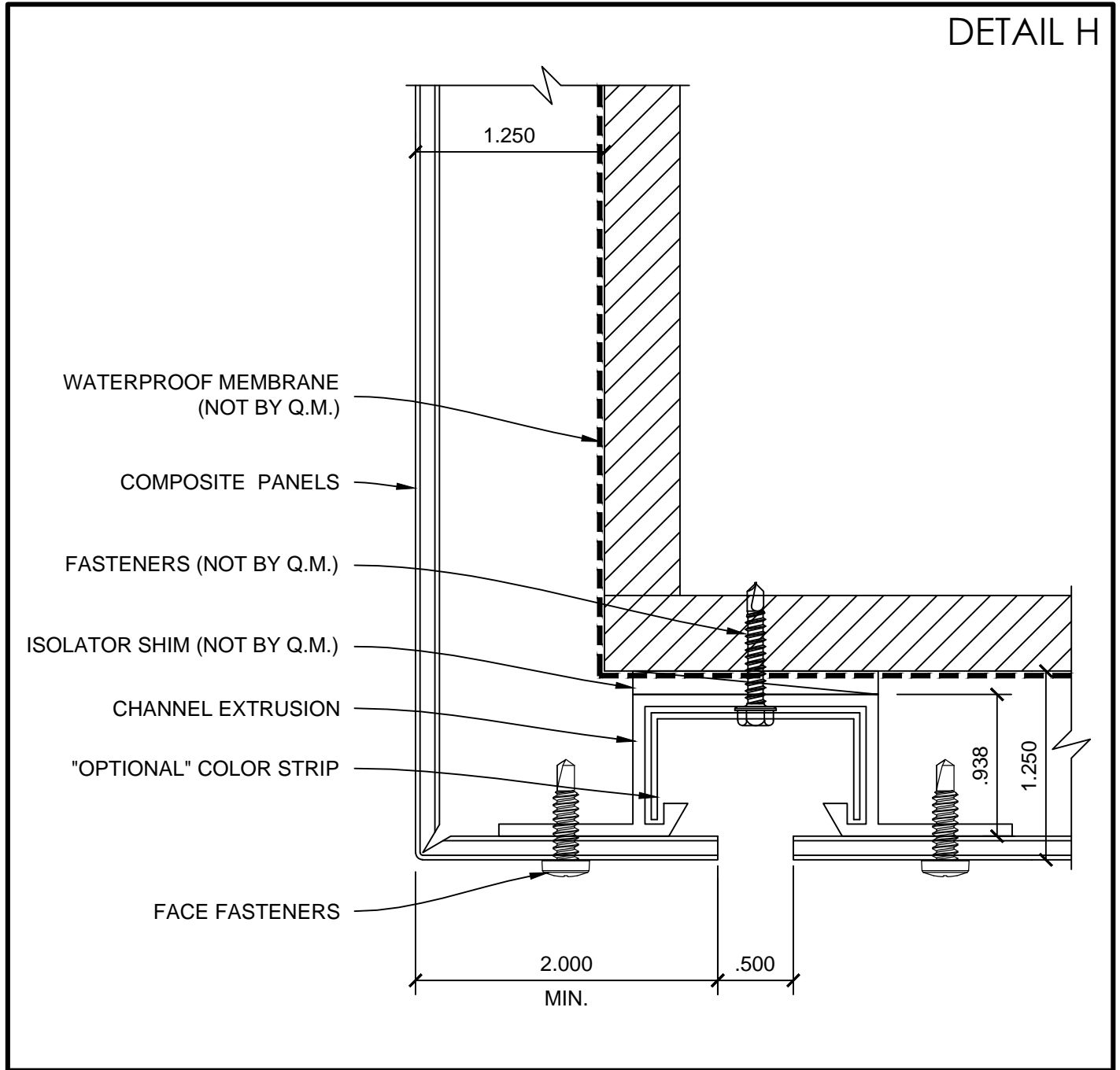

WINDOW JAMB DETAIL

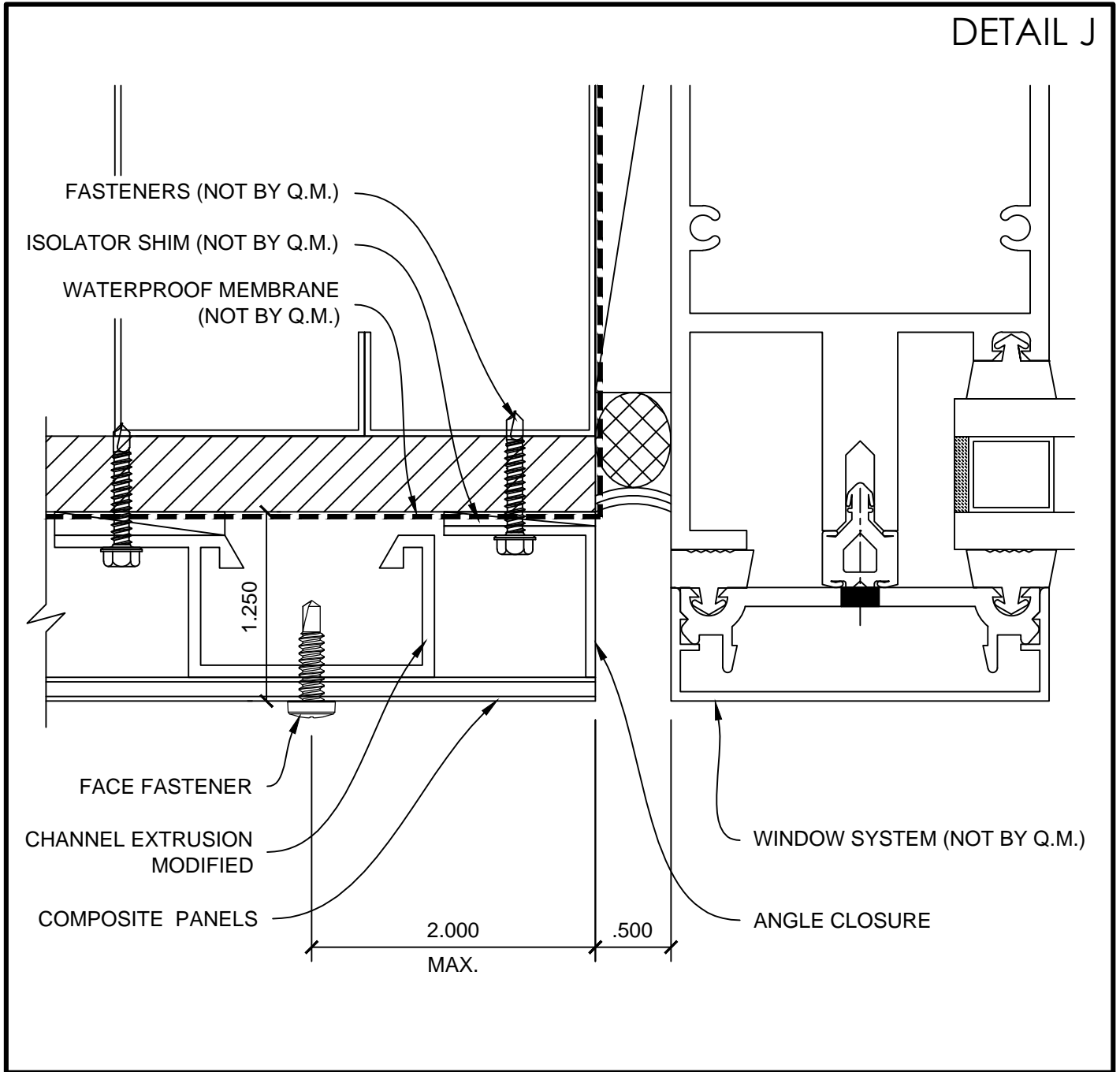

WINDOW HEAD DETAIL

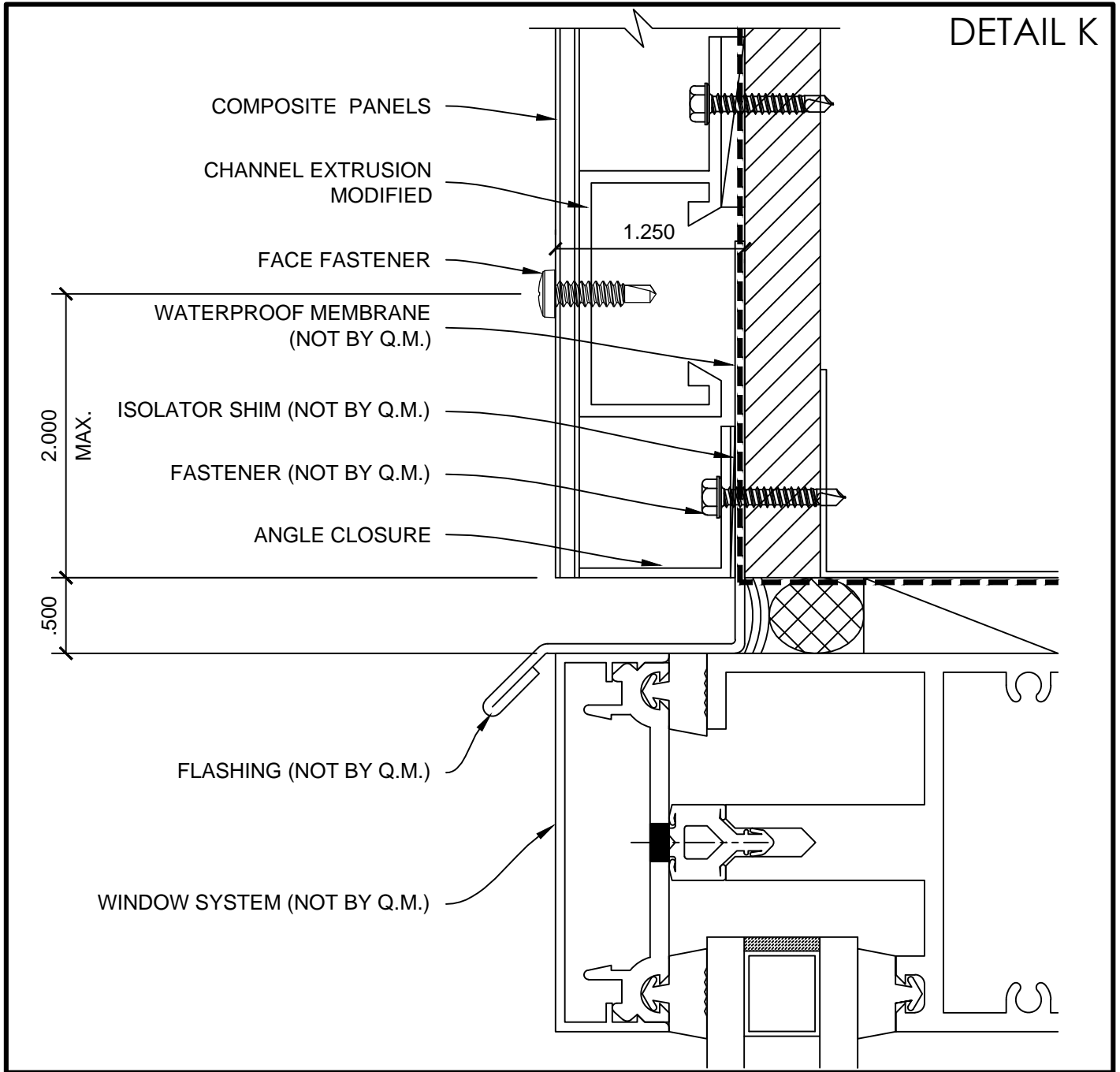

WINDOW SILL DETAIL

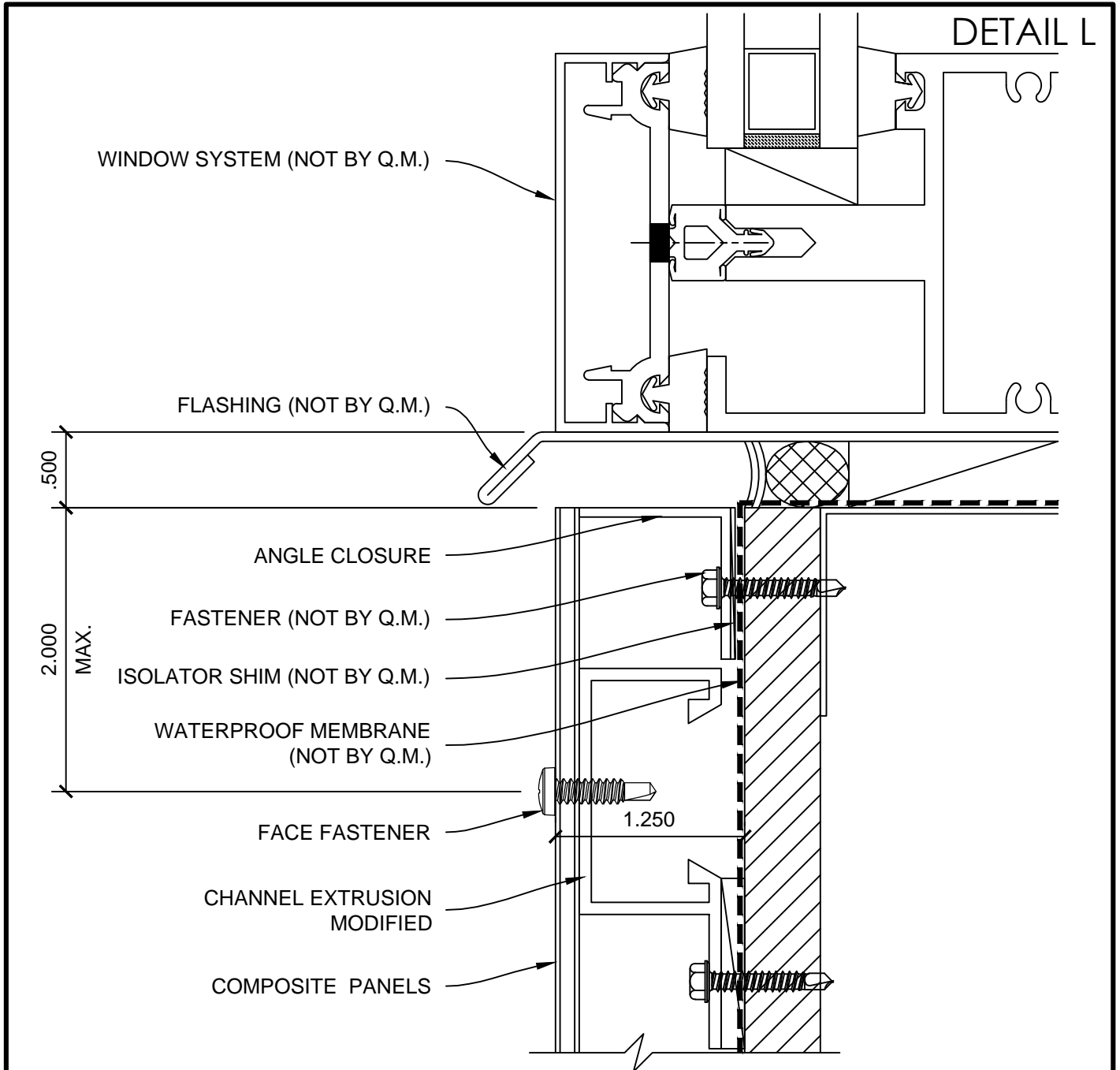

BASE DETAIL

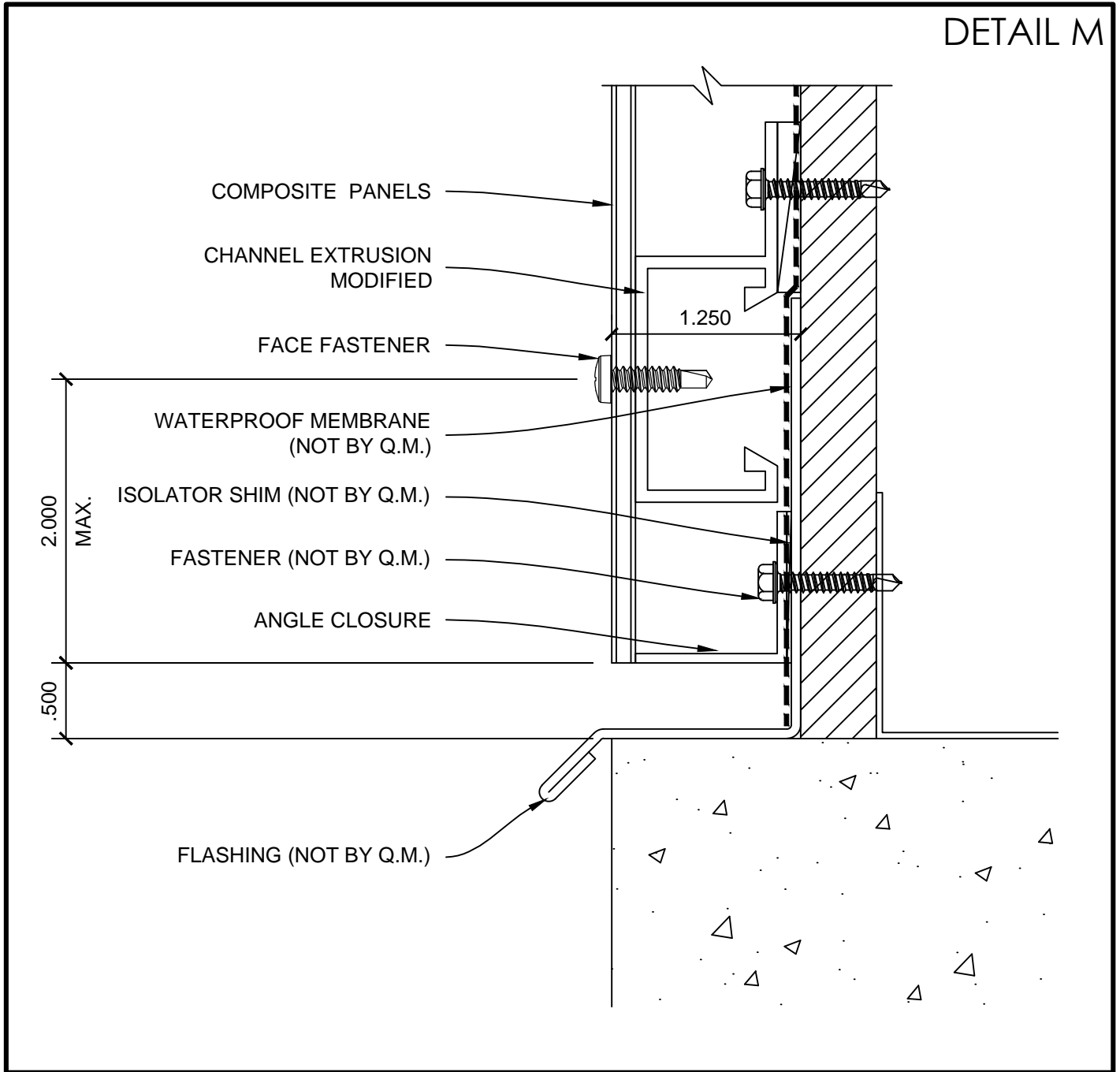

INSIDE CORNER DETAIL (1)

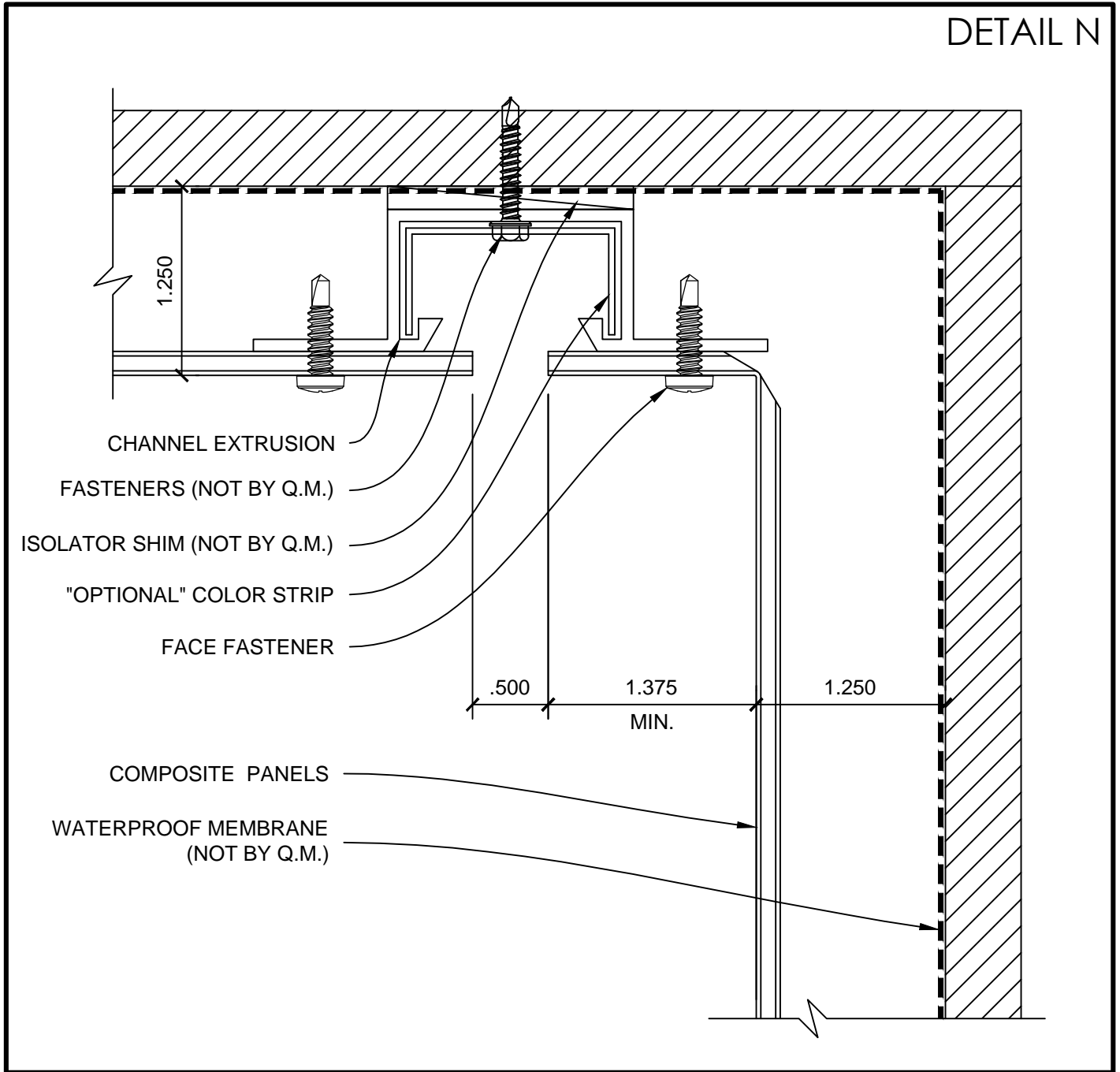

INSIDE CORNER DETAIL (2)

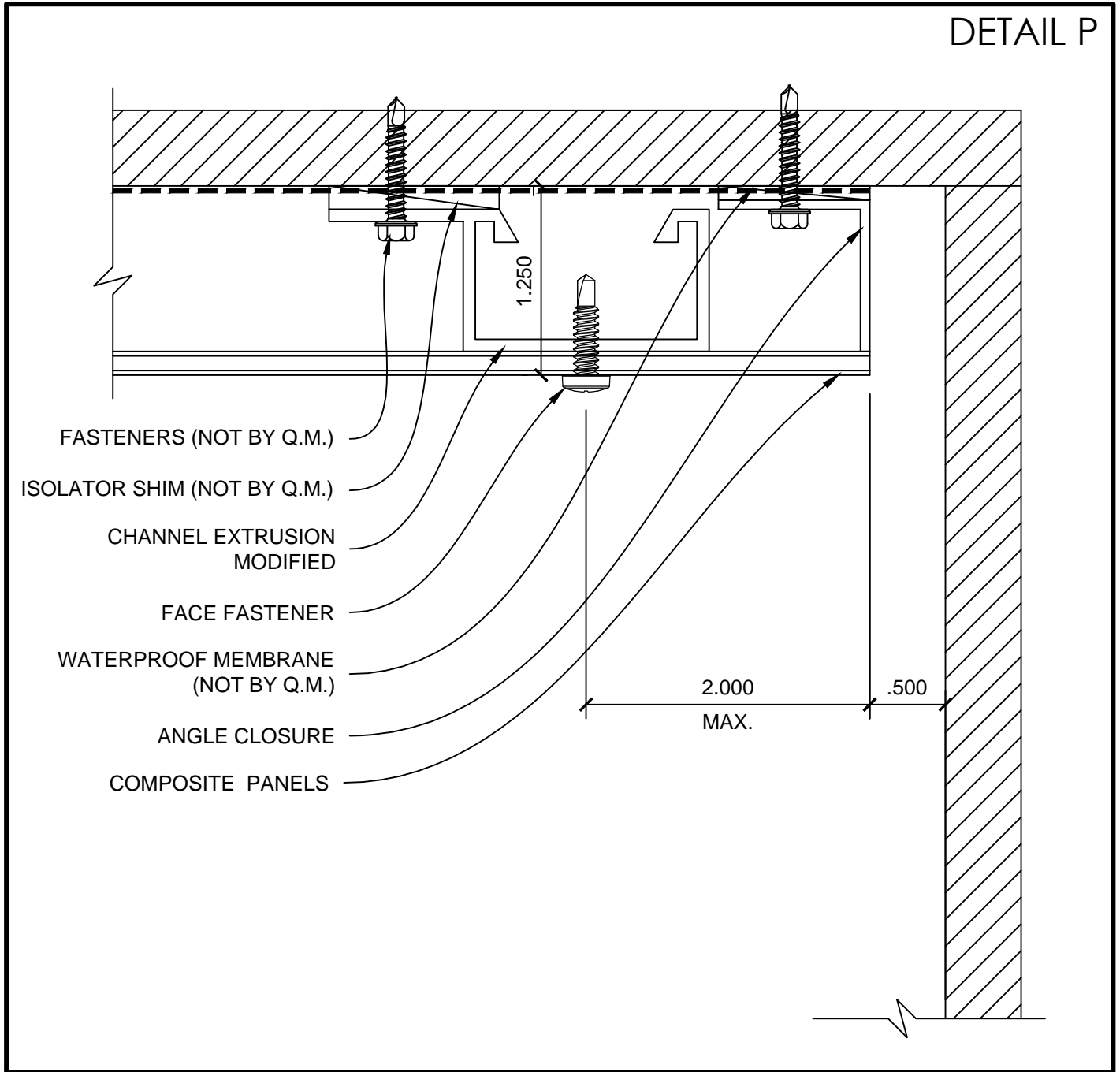

OUTSIDE CORNER DETAIL

